

VSB-50 Solid Bronze Bushing Plugged Graphite Bushings



Solid bronze bushing, Plugged Graphite Bushings or groove design. ■

Materials

Support material: CuZn25A16Fe3Mn4

Sliding layer : Solid lubricant surface: app. 25-30%

Other commonly used bronze alloys: C86300, C86200 C93200, C95400, RG7, CuSn5Zn5Pb5
CuSn6Zn6Pb3, CuAl10Ni, CuSn12Pb, CuSn7ZnPb bronze bearings.

Tolerance Details

Housing $\text{Ø}H7$

Bushing inner- Ø after mounting

Pls consult our sales engineers, standard delivered tolerance: r6 or E7

Shaft tolerance f7 or h6

VSB-50 Solid Bushing Bronze With Lubricant Plugs

Material Composition And Properties

Material	50	50S1	50S2	50S3	50S5	50HP
Chinese Material	CuZn25Al5Mn4Fe3	CuSn5Pb5Zn5	CuAl10Ni5Fe5	CuSn12	CuZn25Al5Mn4Fe3	CuZn32Al5Ni3
Density	8	8.9	7.8	8.9	8	8
Hardness (HB)	>210	>70	>150	>95	>250	>280
Tensile Strength N/mm ²	>750	>200	>600	>260	>800	>540
Yield Strength N/mm ²	>450	>90	>260	>150	>450	>450
Elongation%	>12	>15	>10	>8	>8	>0.3
Coefficient of Linear Expansion	$1.9 \times 10^{-5}/^{\circ}\text{C}$	$1.8 \times 10^{-5}/^{\circ}\text{C}$	$1.6 \times 10^{-5}/^{\circ}\text{C}$	$1.8 \times 10^{-5}/^{\circ}\text{C}$	$1.9 \times 10^{-5}/^{\circ}\text{C}$	$1.8 \times 10^{-5}/^{\circ}\text{C}$
Temperature ^o C	-40 ~ +300 ^o C	-40 ~ +400 ^o C	-40 ~ +400 ^o C	-40 ~ +400 ^o C	-40 ~ +150 ^o C	-40 ~ +150 ^o C
Max. Load Capacity Dynamic N/mm ²	100	60	50	70	120	150
Max. Sliding Speed m/min	15	10	20	10	15	15
Max. PV-value (lubricating) N/mm ² *m/min	200	60	60	80	200	200
Amount of permanent compression deformation/300N/mm ²	<0.01mm	<0.05mm	<0.04mm	<0.05mm	<0.005mm	<0.005mm

Solid Lubricant

Solid Lubricant

Features

Typical application

Graphite+add

Good wear performance and chemical stability, temperature limit 400^oC

Suit for general machines and under atmosphere

PTFE + add

Lowest friction coefficient and good water lubrication, temperature limit 300^oC

Suit for water and seawater lubricant, such as ship

VSB-50

Cylindrical Bushes (I.D \varnothing 6 ~ \varnothing 45)



Please select part number from applicable inside diameter, outside diameter and length
e.g. the inner diameter: 25mm, the outer diameter: 33mm and the length is 20mm

VSB-50 - 253320

Please specify the above part number

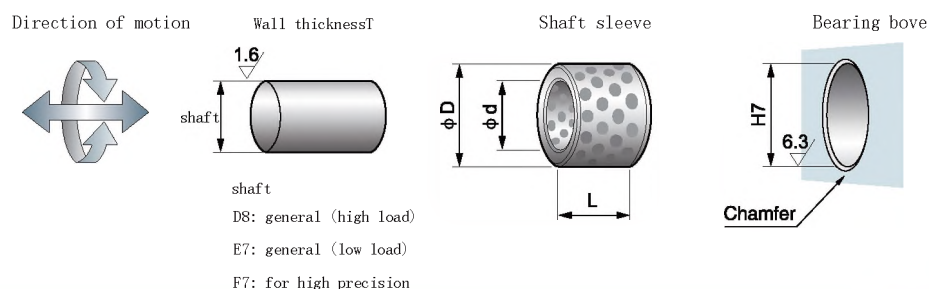

ID	OD	L $\begin{matrix} -0.1 \\ -0.3 \end{matrix}$									
$\varnothing d$	$\varnothing D$	8	10	12	15	16	19	20	25		
6	+0.022 +0.010	10	+0.015 +0.006	061008	061010	061012					
8	+0.028 +0.013	12	+0.018 +0.007	081208	081210	081212	081215				
10	"	14	"	101408	101410	101412	101415			101420	
12	+0.034 +0.016	18	"	121808	121810	121812	121815	121816	121819	121820	121825
13	"	19	+0.021 +0.008		131910	131912	131915			131920	131925
14	"	20	"		142010	142012	142015			142020	142025
15	"	21	"		152110	152112	152115	152116		152120	152125
16	"	22	"		162210	162212	162215	162216	162219	162220	162225
17	"	23	"				172315				
18	"	24	"		182410	182412	182415	182416		182420	182425
19	+0.041 +0.020	26	"				192615			192620	
20	"	28	"		202810	202812	202815	202816	202819	202820	202825
"	"	30	"		203010	203012	203015	203016		203020	203025
22	"	32	+0.025 +0.009			223212	223215			223220	223225
25	"	33	"			253312	253315	253316		253320	253325
"	"	35	"			253512	253515	253516		253520	253525
28	"	38	"							283820	283825
30	"	"	"			303812	303815			303820	303825
"	"	40	"			304012	304015			304020	304025
31.5	+0.050 +0.025	"	"								
32	"	42	"							324220	
35	"	44	"							354420	354425
"	"	45	"							354520	354525
38	"	48	"								
40	"	50	"				405015			405020	405025
"	"	55	+0.030 +0.011				405515				
45	"	"	"								
"	"	56	"								
"	"	60	"								

※ bore tolerance after pressing is the reference value

VSB-50

Cylindrical Bushes(I.D \varnothing 6 ~ \varnothing 45)

- can be used in rotation, shaking and reciprocating motion
- cannot be used in seawater.
- the axle sleeve with inner diameter of 31.5mm • 63mm can be applied to the sleeve of oil pressure cylinder.

To prevent it from falling off.
A stop pin is recommended

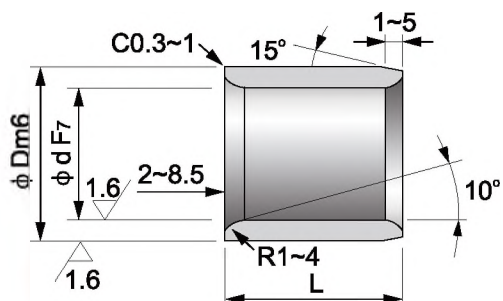
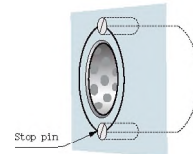

							L ^{+0.1} _{-0.3}	After the pressureApply the gasket into the inside diameter tolerance	SPW	ID ød
30	35	40	50	60	70	80	+0.019 +0.007 +0.025 +0.010	0603	6	
							"	0803	8	
							"	1003	10	
121830							+0.031 +0.013 +0.030 +0.012	1203	12	
131930							"	1303	13	
142030							"	1403	14	
152130	152135	152140					"	1503	15	
162230	162235	162240					"	1603	16	
							"	1803*	17	
182430	182435	182440					"	1803	18	
							+0.037 +0.016	2005*	19	
202830	202835	202840	202850				"	2005	20	
203030	203035	203040	203050				"	2505*	"	
							"	"	22	
253330	253335	253340	253350	253360			"	2505	25	
253530	253535	253540	253550	253560			"	3005*	"	
283830		283840					"	"	28	
303830	303835	303840	303850	303860			"	3005	30	
304030	304035	304040	304050	304060			"	3505*	"	
314030		314040					+0.046 +0.021	"	31.5	
324230		324240					"	"	32	
354430	354435	354440	354450	354460			"	3505	35	
354530	354535	354540	354550	354560			"	4007*	"	
		384840					"	"	38	
405030	405035	405040	405050	405060	405070	405080	"	4007	40	
405530	405535	405540	405550	405560			+0.045 +0.020	4507*	"	
455530	455535	455540	455550	455560			"	4507	45	
455630	455635	455640	455650	455660			"	"	"	
456030	456035	456040	456050	456060	456070	456080	"	"	"	

VSB-50

Cylindrical bushes (I.D. $\varnothing 50 \sim \varnothing 200$)



Please select part number from applicable inside diameter, outside diameter and length
e.g. inner diameter: 80mm, the outer diameter: 96mm and the length is 70 mm

VSB-50 - 809670

Please specify the above part number

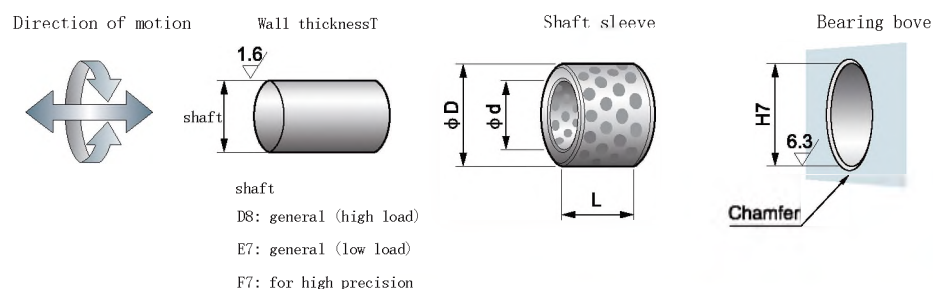

ID	OD	L ^{-0.1} / _{-0.3}									
ød	øD	20	30	35	40	50	60	70	80		
50	+0.050 +0.025	60	+0.030 +0.011	506020	506030	506035	506040	506050	506060	506070	506080
"	"	62	"		506230	506235	506240	506250	506260	506270	506280
"	"	65	"		506530		506540	506550	506560	506570	506580
55	+0.060 +0.030	70	"		557030	557035	557040	557050	557060	557070	
60	"	74	"		607430	607435	607440	607450	607460	607470	607480
"	"	75	"		607530	607535	607540	607550	607560	607570	607580
63	"	"	"						637560	637570	637580
65	"	80	"				658040	658050	658060	658070	658080
70	"	85	+0.035 +0.013		708530	708535	708540	708550	708560	708570	708580
"	"	90	"					709050	709060	709070	709080
75	"	"	"					759050	759060	759070	759080
"	"	95	"						759560	759570	759580
80	"	96	"				809640	809650	809660	809670	809680
"	"	100	"				8010040	8010050	8010060	8010070	8010080
85	+0.071 +0.036	"	"						8510060		8510080
90	"	110	"					9011050	9011060		9011080
100	"	120	"					10012050	10012060	10012070	10012080
110	"	130	+0.040 +0.015					11013050		11013070	11013080
120	"	140	"							12014070	12014080
125	+0.083 +0.043	145	"								
130	"	150	"								13015080
140	"	160	"								
150	"	170	"								15017080
160	"	180	"								16018080
170	"	190	+0.046 +0.017								
180	"	200	"								
190	+0.096 +0.050	210	"								
200	"	230	"								

※ bore tolerance after pressing is the reference value

VSB-50

Cylindrical Bushes (I.D. $\varnothing 50 \sim \varnothing 200$)

- can be used in rotation, shaking and reciprocating motion
- cannot be used in seawater.
- the axle sleeve with inner diameter of 31.5mm • 63mm can be applied to the middle axle sleeve neck sleeve of oil pressure cylinder.

To prevent it from falling off.
A stop pin is recommended

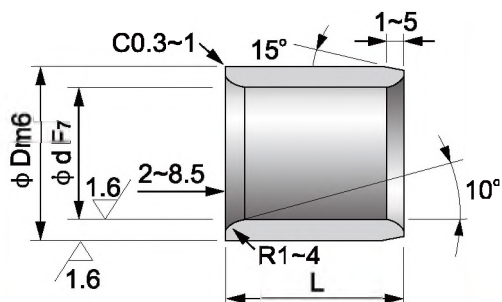
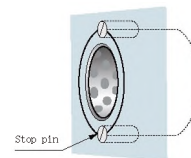

90	100	120	130	140	150	200	After the pressure into the inside diameter tolerance	Apply the gasket SPW	ID $\varnothing d$
							+0.045 +0.020	5008	50
							"	"	"
	5065100						"	"	"
							+0.055 +0.025	5508	55
							"	6008	60
	6075100						"	"	"
							"	6508	63
							"	6508	65
	7085100						+0.054 +0.024	7010	70
							"	"	"
	7590100						"	7510	75
	7595100						"	"	"
	8096100	8096120					"	8010	80
	80100100	80100120		80100140			"	"	"
							+0.065 +0.030	9010	85
9011090	90110100	90110120					"	9010	90
10012090	100120100	100120120		100120140			"	10010	100
	110130100	110130120					+0.064 +0.029	12010	110
12014090	120140100	120140120		120140140			"	12010	120
	125145100	125145120					+0.076 +0.036	—	125
	130150100		130150130				"	"	130
	140160100			140160140			"	"	140
	150170100				150170150		"	"	150
	160180100				160180150		"	"	160
	170190100				170190150		"	"	170
	180200100				180200150		"	"	180
	190210100				190210150		+0.088 +0.042	"	190
					200230150	200230200	"	"	200

VSB-50F

Flanged Bushes



Please select part number from applicable inside diameter, outside diameter and length
e.g. inner diameter : 50mm and length: 30mm

VSB-50F - 5030

Please specify the above part number

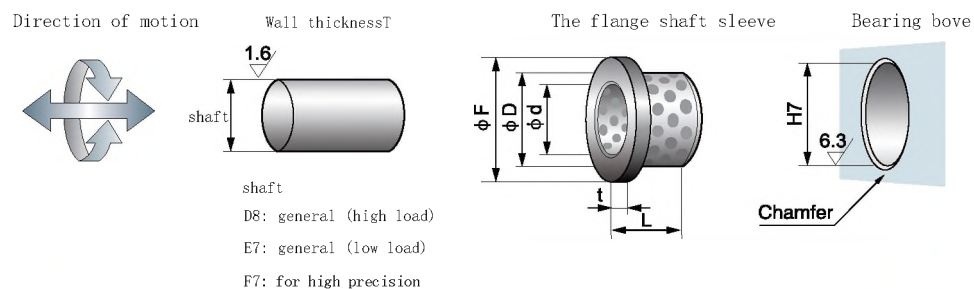

ID	OD	Flange		L ^{-0.1} / _{-0.3}							
ø d	ø D	ø F	t	10	12	15	17	18	20	23	25
6	+0.032 +0.020	10 +0.028 +0.019	16 2	0 -0.1	0610	0612					
8	+0.040 +0.025	12 +0.034 +0.023	20 "	"	0810	0812	0815				
10	"	14 "	22 "	"	1010	1012	1015	1017	1020		
12	+0.050 +0.032	18 "	25 3	"	1210	1212	1215		1220		1225
13	"	19 +0.041 +0.028	26 "	"	1310	1312	1315		1320		1325
14	"	20 "	27 "	"			1415		1420		1425
15	"	21 "	28 "	"	1510	1512	1515		1520		1525
16	"	22 "	29 "	"		1612	1615	1618	1620	1623	1625
18	"	24 "	32 "	"			1815		1820		1825
20	+0.061 +0.040	30 "	40 5	"			2015		2020		2025
25	"	35 +0.050 +0.034	45 "	"			2515		2520		2525
30	"	40 "	50 "	"					3020		3025
31.5	+0.075 +0.050	"	"	"					3120		
35	"	45 "	60 "	"					3520		3525
40	"	50 "	65 "	"					4020		4025
45	"	55 +0.060 +0.041	70 "	"							
50	"	60 "	75 "	"							
55	+0.090 +0.060	65 "	80 "	"							
60	"	75 +0.062 +0.043	90 7.5	"							
63	"	"	85 "	"							
65	"	80 "	95 "	"							
70	"	85 +0.073 +0.051	105 "	"							
75	"	90 "	110 "	"							
80	"	100 "	120 10	"							
90	+0.107 +0.072	110 +0.076 +0.054	130 "	"							
100	"	120 "	150 "	"							
120	"	140 +0.088 +0.063	170 "	"							
130	+0.125 +0.085	150 +0.090 +0.065	180 "	"							
140	"	160 "	190 "	"							
150	"	170 +0.093 +0.068	200 "	"							
160	"	180 "	210 "	"							

※ bore tolerance after pressing is the reference value

VSB-50F

Flanged Bushes

- can use and rotate, shake motion and reciprocating motion.
- in the flange part because there is no insert lubricant, can not bear the axial load.
- avoid seawater.
- The inner diameter of 31.5mm • 63mm is the product used on the intermediate shaft sleeve of the oil pressure cylinder.

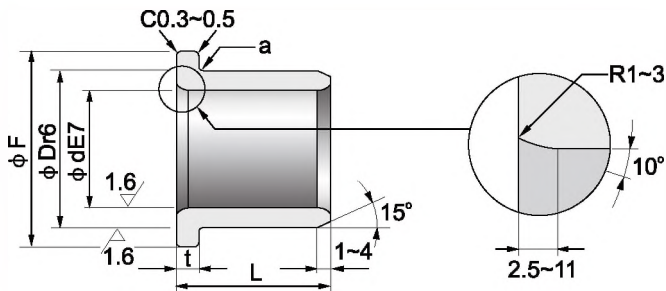

A: Chamfered at the lower end(mm)

∅d	~ 1.6	~ 55	~ 160
a	R0.3	R0.5	R1

										L _{-0.1} -0.3	After the pressure into the inside diameter tolerance	ID ∅d
30	35	40	50	60	67.5	80	100	120			+0.016 +0.004	6
											+0.021 +0.006	8
											"	10
1230											+0.031 +0.013	12
1330											+0.028 +0.008	13
											"	14
1530											"	15
1630	1635	1640									"	16
1830	1835	1840									"	18
2030	2035	2040									+0.037 +0.016	20
2530	2535	2540	2550								+0.032 +0.011	25
3030	3035	3040	3050								"	30
3130	3135	3140									+0.046 +0.021	31.5
3530	3535	3540	3550								"	35
4030	4035	4040	4050								"	40
4530	4535	4540	4550	4560							+0.040 +0.015	45
5030	5035	5040	5050	5060							"	50
		5540		5560							+0.055 +0.025	55
		6040	6050	6060		6080					+0.053 +0.023	60
					6367						"	63
				6560							"	65
			7050			7080					+0.046 +0.016	70
				7560							"	75
				8060		8080	80100				"	80
				9060		9080					+0.060 +0.025	90
						10080	100100				"	100
						12080	120100				+0.052 +0.017	120
						13080	130100				+0.068 +0.028	130
						14080	140100				"	140
							150100	150120			+0.065 +0.025	150
							160100	160120			"	160

VSB-50FG

Flanged Bushes



Please select part number from applicable inside diameter, outside diameter and length
e.g. inner diameter: 50mm and length: 30mm

VSB-50FG - 5030

Please specify the above part number

Direction of motion

Wall thickness T

The flange shaft sleeve

Bearing bore

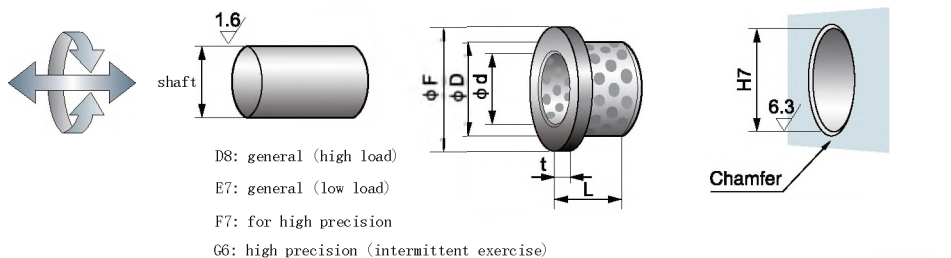

ID	OD	Flange		L						
ϕd	ϕD	ϕF	t	11	13	18	20	23	25	
6	+0.032 +0.020	10	+0.028 +0.019	16	2	0 -0.1	0611			
8	+0.040 +0.025	12	+0.034 +0.023	20	"	"	0813			
10	"	14	"	22	"	"	1013	1018		
12	+0.050 +0.032	18	"	25	3	"	1211	1218	1223	
13	"	19	+0.041 +0.028	26	"	"	1313	1318	1323	
14	"	20	"	27	"	"	1513	1518	1523	
15	"	21	"	28	"	"	1613	1618	1623	
16	"	22	"	29	"	"	1818		1823	
18	"	24	"	32	"	"		2020	2025	
20	+0.061 +0.040	30	"	40	5	"		2520	2525	
25	"	35	+0.050 +0.034	45	"	"		3020	3025	
30	"	40	"	50	"	"		3520	3525	
31.5	+0.075 +0.050	"	"	"	"	"				
35	"	45	"	60	"	"				
40	"	50	"	65	"	"				
45	"	55	+0.060 +0.041	70	"	"				
50	"	60	"	75	"	"				

※ bore tolerance after pressing is the reference value.

VSB-50FG

Flanged Bushes

- can be used in rotation, shaking and reciprocating motion.
- the same bushing can bear radial and axial load when it is used.
- The precision of flange thickness can improve the mechanical precision.

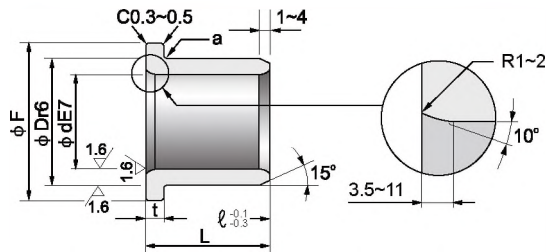

A: Chamfered at the lower end (mm)

ϕd	~ 50	60 ~
a	R0.5	R1

L												After the pressure into the inside diameter tolerance	ID ϕd
27	35	37	38	47	48	50	58	60	68	80	90		
												+0.016 +0.004	6
												+0.021 +0.006	8
												"	10
												+0.031 +0.013	12
												+0.026 +0.008	13
												"	15
												"	16
												"	18
												+0.037 +0.016	20
												+0.032 +0.011	25
	3035											"	30
	3535											+0.046 +0.021	35
4027		4037		4047								"	40
			5038		5048		5058					+0.040 +0.015	50
			6038		6048		6058		6068			+0.053 +0.023	60
						7050				7080		+0.046 +0.016	70
							8060				8090	"	80

VSB-50W

Thrust Washers



● can be used in combination with VSB-50.

Please select part number from applicable inside diameter, outside diameter and length e.g. inner diameter: 30.2mm and the thickness: 5mm

VSB-50W - 3005

Please specify the above part number

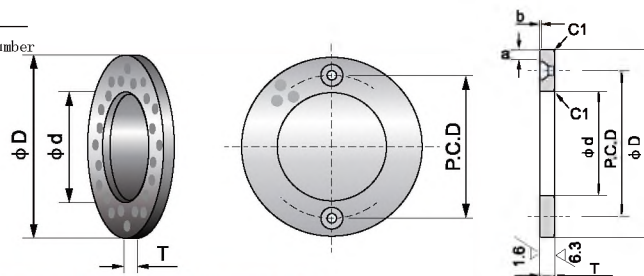

A b: end face chamfering (mm)

d	~ 10.2	~ 18.2	~ 35.2	~ 45.2	~ 55.3	~ 100.5	~ 120.5
a	1.5	2	2.5	3	4	5	4
b	0.3	0.4	0.4	0.5	0.6	0.8	0.8

Parts No.	ID		OD		The thickness of the		Location hole	
	ød		ØD		T	P.C.D	The number of	Locating bolt
VSB -50W-0603	6.2	+0.2 +0.1	25		3	15	2	M3
VSB -50W-0803	8.2	"	28		"	18	"	"
VSB -50W-1003	10.2	"	30		"	20	"	"
VSB -50W-1203	12.2	"	40		"	28	"	"
VSB -50W-1203N	"	"	"		"		No positioning hole	
VSB -50W-1303	13.2	"	"		"	28	2	M3
VSB -50W-1403	14.2	"	"		"	"	"	"
VSB -50W-1503	15.2	"	50		"	35	"	"
VSB -50W-1603	16.2	"	"		"	"	"	"
VSB -50W-1603N	"	"	"		"		No positioning hole	
VSB -50W-1803	18.2	"	"		"	35	2	M3
VSB -50W-2005	20.2	"	"		5	"	"	M5
VSB -50W-2505	25.2	"	55		"	40	"	"
VSB -50W-2505N	"	"	"		"		No positioning hole	
VSB -50W-3005	30.2	"	60		"	45	2	M5
VSB -50W-3005N	"	"	"		"		No positioning hole	
VSB -50W-3505	35.2	"	70		"	50	2	M5
VSB -50W-4007	40.2	+0.2 +0.1	80		7	60	2	M6
VSB -50W-4507	45.2	"	90		"	70	"	"
VSB -50W-5008	50.3	+0.3 +0.1	100		8	75	4	"
VSB -50W-5508	55.3	"	110		"	85	"	"
VSB -50W-6008	60.3	"	120		"	90	"	M8
VSB -50W-6508	65.3	"	125		"	95	"	"
VSB -50W-7010	70.3	"	130		10	100	"	"
VSB -50W-7510	75.3	"	140		"	110	"	"
VSB -50W-8010	80.3	"	150		"	120	"	"
VSB -50W-9010	90.5	"	170		"	140	"	M10
VSB -50W-10010	100.5	"	190		"	160	"	"
VSB -50W-12010	120.5	"	200		"	175	"	"

VSB-50SW

Wear Plate-20mm Thick



Please select part number from applicable length, width and thickness

VSB-50SW - 75200

Please specify the above part number

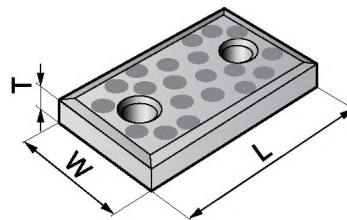

● the direction of motion is vertical and horizontal

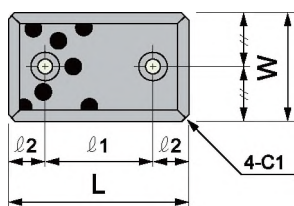

The section shape

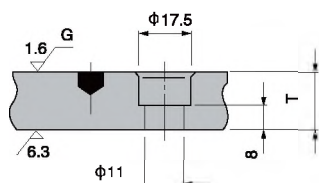

Chamfering shape
Type A

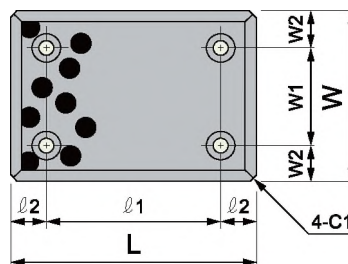
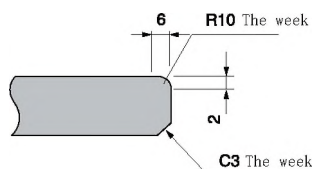

Direction of motion



B type

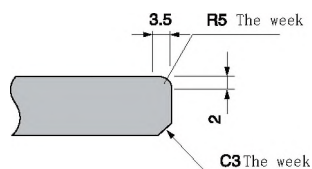

VSB-50SW

Wear Plate-20mm Thick

Parts No.	Wide		Long		The thickness of the		Locating hole clearance				Location hole chamfering			
	W		L		T		W ₁	W ₂	ℓ ₁	ℓ ₂	The number of	The shape of		
VSB -50SW-4875	48	$\begin{matrix} -0.1 \\ -0.3 \end{matrix}$	75	$\begin{matrix} -0.1 \\ -0.3 \end{matrix}$	20	± 0.025	-	± 0.2	-	45	± 0.2	15	2	B
VSB -50SW-48100	"	"	100	"	"	"	"	"	"	50	"	25	"	"
VSB -50SW-48125	"	"	125	"	"	"	"	"	"	75	"	"	"	"
VSB -50SW-48150	"	"	150	"	"	"	"	"	"	100	"	"	"	"
VSB -50SW-7575B	75	"	75	"	"	"	"	"	"	25	"	"	"	A
VSB -50SW-75100B	"	"	100	"	"	"	"	"	"	50	"	"	"	"
VSB -50SW-75125	"	"	125	"	"	"	"	"	"	75	"	"	"	"
VSB -50SW-75150	"	"	150	"	"	"	"	"	"	100	"	"	"	"
VSB -50SW-75200	"	"	200	"	"	"	"	"	"	150	"	"	"	"
VSB -50SW-100100	100	"	100	"	"	"	50	"	25	50	"	"	4	"
VSB -50SW-100125	"	"	125	"	"	"	"	"	"	75	"	"	"	"
VSB -50SW-100150	"	"	150	"	"	"	"	"	"	100	"	"	"	"
VSB -50SW-100200	"	"	200	"	"	"	"	"	"	150	"	"	"	"
VSB -50SW-100250	"	"	250	"	"	"	"	"	"	200	"	"	"	"
VSB -50SW-125150	125	"	150	"	"	"	"	"	37.5	100	"	"	"	"
VSB -50SW-125200	"	"	200	"	"	"	"	"	"	150	"	"	"	"
VSB -50SW-125250	"	"	250	"	"	"	"	"	"	200	"	"	"	"
VSB -50SW-150150	150	"	150	"	"	"	100	"	25	100	"	"	"	"
VSB -50SW-150200	"	"	200	"	"	"	"	"	"	150	"	"	"	"
VSB -50SW-150250	"	"	250	"	"	"	"	"	"	200	"	"	"	"

VSB-50SW

Wear plate-10mm Thick



Please select part number from applicable length, width and thickness

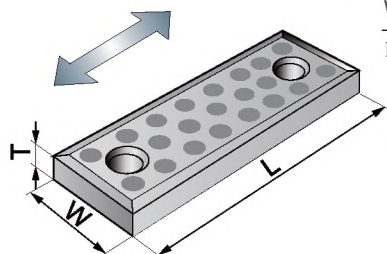

VSB-50SW - 28150

Please specify the above part number

● the direction of motion is vertical and horizontal

W=18、28、38、48

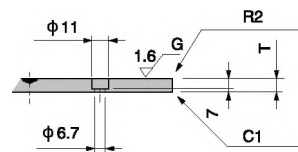
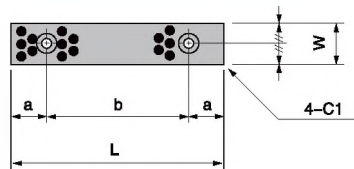

The section shape

Parts No.	Wide	Long	The thickness of the		Locating bolt			
	W	L	T		a	b	Type	Type
VSB -50SW-1875	18	75	10	$\begin{smallmatrix} +0.04 \\ +0.01 \end{smallmatrix}$	15	45	M6	2
VSB -50SW-18100	"	100	"	"	25	50	"	"
VSB -50SW-18125	"	125	"	"	"	75	"	"
VSB -50SW-18150	"	150	"	"	"	100	"	"
VSB -50SW-2875	28	75	"	"	15	45	"	"
VSB -50SW-28100	"	100	"	"	25	50	"	"
VSB -50SW-28125	"	125	"	"	"	75	"	"
VSB -50SW-28150	"	150	"	"	"	100	"	"
VSB -50SW-3875	38	75	"	"	15	45	"	"
VSB -50SW-38100	"	100	"	"	25	50	"	"
VSB -50SW-38125	"	125	"	"	"	75	"	"
VSB -50SW-38150	"	150	"	"	"	100	"	"
VSB -50SW-4875	48	75	"	"	15	45	"	"
VSB -50SW-48100	"	100	"	"	25	50	"	"
VSB -50SW-48125	"	125	"	"	"	75	"	"
VSB -50SW-48150	"	150	"	"	"	100	"	"

VSB-500

Bronze Groove self - Lubricating Bearing

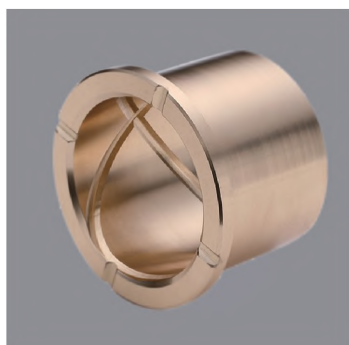

VSB-500

Please specify the above part number

Direction of motion

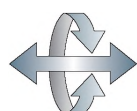

Wall thickness T

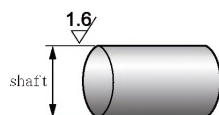

D8: general (high load)

E7: general (low load)

F7: for high precision

G6: high precision (intermittent exercise)

The flange shaft sleeve

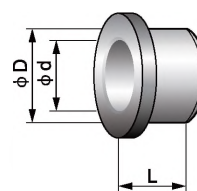

Bearing

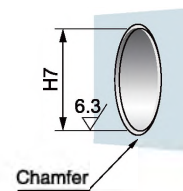

Groove Type

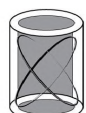

Double Loop

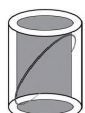

Single Loop



Straight



Circular

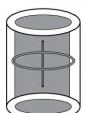

Straight & Circular

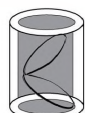
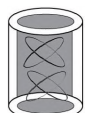

Figure Eight



Double Figure Eight



X mode

Model/ corresponding brand	VSB-500						
	VSB-500-1	VSB-500-2	VSB-500-3	VSB-500-4	VSB-500-5	VSB-500-6	VSB-500-7
GB1776 87	ZCuZn25 Al6Fe3Mn3	ZCuSn6Zn6Pb3	ZCuAl10Fe3	ZCuSu10P1	steel+ ZCuSn6Zn6Pb3	IIT250	GCr15
ISO1338	GCuZn25 Al6Fe3Mn3	GCuSn6Zn6Pb3	GCuAl10Fe3	-	steel+ CuSn6Zn6Pb3 Fe3Ni5	-	B1
DIN	G-CuZn25 Al5	GB-CuSn5Zn5Pb5	GB-CuAl10Ni	GB-CuSn10	steel+ CuSn6Zn6Pb3Ni	-	100Cr6
ASTM/UNS	C86300	C83600	C95500	C90500	C83600	Class40	52100
IIS	1IBsC4	BC6	AIBC3	BC3	BC6	FC250	SUJ2
(BS)	IITB2	LG2	AB1	PB4	LG2	-	-